

FRONT Spring Installation – SK-POL-026-01

NOTICE

Read ALL instructions before beginning!! This kit should ONLY be installed by a professional service mechanic who is trained in the installation of suspension components.

WARNING

SPRING CHANGES CAN BE DANGEROUS AND SHOULD ONLY BE PERFORMED BY A PROFESSIONAL SERVICE MECHANIC . FAILURE TO FOLLOW THIS RULE COULD RESULT IN INJURY OR DEATH.

Before you begin... understand that no spring kit will be perfect for every type of riding style and terrain. This kit is intended to improve the overall ride quality and longevity compared to the stock setup and provide adjustability with the crossover ring. For maximum performance on any one specific type of riding, additional upgrades including a shock revalve may be recommended. Consult your favorite performance tuner.

NOTICE

For transit, your springs may not be packaged in the same order that they will be installed on the vehicle. **Check all part numbers for proper placement on the vehicle.** Always install the left front springs identical to the right front.

1. Remove the existing springs and clean the threads on the shock. **⚠ Never attempt to remove or install the spring retainer with anything other than an approved spring compressor operated by a professional service mechanic.**
2. Position the existing threaded spring platform 3.50 inches (89 mm) from the top of the shock body as shown in Fig A. ① Measure from the top of the exposed shock body to the surface on the threaded spring platform that the spring sits on. **Due to variation in vehicles, it may be necessary to adjust the platform to achieve desired ride height.**
3. Install the Crossover Ring by removing the locking screw, stretching the ring over the shaft, and then over the end of the shock body. Be sure the threads are aligned and engaged with the body. Reinstall the locking screw.
4. Position the Crossover Ring 6.25 inches (159 mm) from the top of the shock body as shown in Fig A. ② Measure from the **TOP** of the exposed shock body to the **BOTTOM** of the Cross Over Ring. **Tighten the locking screw.**
5. Install the springs by checking the spring part numbers for proper position and slide the Front Secondary Spring, Front Slider, and Front Main Spring into the position as shown in Fig B.
6. Install the spring retainer and any other hardware that was removed. **⚠ Never attempt to remove or install the spring retainer with anything other than an approved spring compressor operated by a professional service mechanic**
7. Front ride height should be 16.50"-17.50" with stock wheels/tires inches from ground to lower arm bolt.

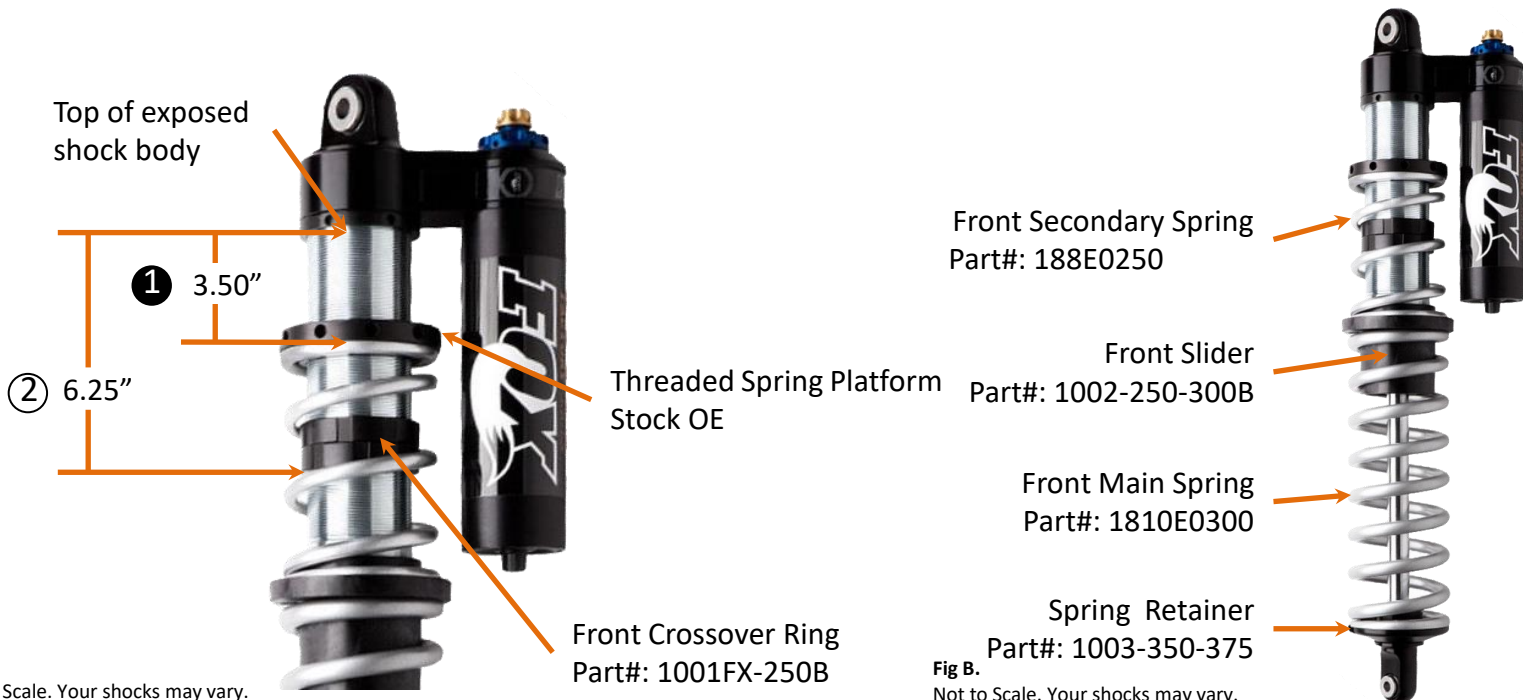

REAR Spring Installation – SK-POL-026-01

NOTICE

Read ALL instructions before beginning!! This kit should ONLY be installed by a professional service mechanic who is trained in the installation of suspension components.

WARNING

SPRING CHANGES CAN BE DANGEROUS AND SHOULD ONLY BE PERFORMED BY A PROFESSIONAL SERVICE MECHANIC . FAILURE TO FOLLOW THIS RULE COULD RESULT IN INJURY OR DEATH.

Before you begin... understand that no spring kit will be perfect for every type of riding style and terrain. This kit is intended to improve the overall ride quality and longevity compared to the stock setup and provide adjustability with the crossover ring. For maximum performance on any one specific type of riding, additional upgrades including a shock revalve may be recommended. Consult your favorite performance tuner.

NOTICE

For transit, your springs may not be packaged in the same order that they will be installed on the vehicle. **Check all part numbers for proper placement on the vehicle.** Always install the left rear springs identical to the right rear.

1. Remove the existing springs and clean the threads on the shock. **⚠ Never attempt to remove or install the spring retainer with anything other than an approved spring compressor operated by a professional service mechanic.**
2. Position the existing threaded spring platform 2.75 inches (70 mm) from the top of the shock body as shown in Fig A. ① Measure from the top of the exposed shock body to the surface on the threaded spring platform that the spring sits on. **Due to variation in vehicles, it may be necessary to adjust the platform to achieve desired ride height.**
3. Install the Crossover Ring by removing the locking screw, stretching the ring over the shaft, and then over the end of the shock body. Be sure the threads are aligned and engaged with the body. Reinstall the locking screw.
4. Position the Crossover Ring 6.75 inches (171 mm) from the top of the shock body as shown in Fig A. ② Measure from the **TOP** of the exposed shock body to the **BOTTOM** of the Cross Over Ring. **Tighten the locking screw.**
5. Install the springs by checking the spring part numbers for proper position and slide the Rear Secondary Spring, Rear Slider, and Rear Main Spring into the position as shown in Fig B.
6. Install the spring retainer and any other hardware that was removed. **⚠ Never attempt to remove or install the spring retainer with anything other than an approved spring compressor operated by a professional service mechanic**
7. Rear ride height should be 16.50"-17.50" with stock wheels/tires inches from ground to lower arm bolt.

